

Individual mounting

sub-base
"plug-in"

Series

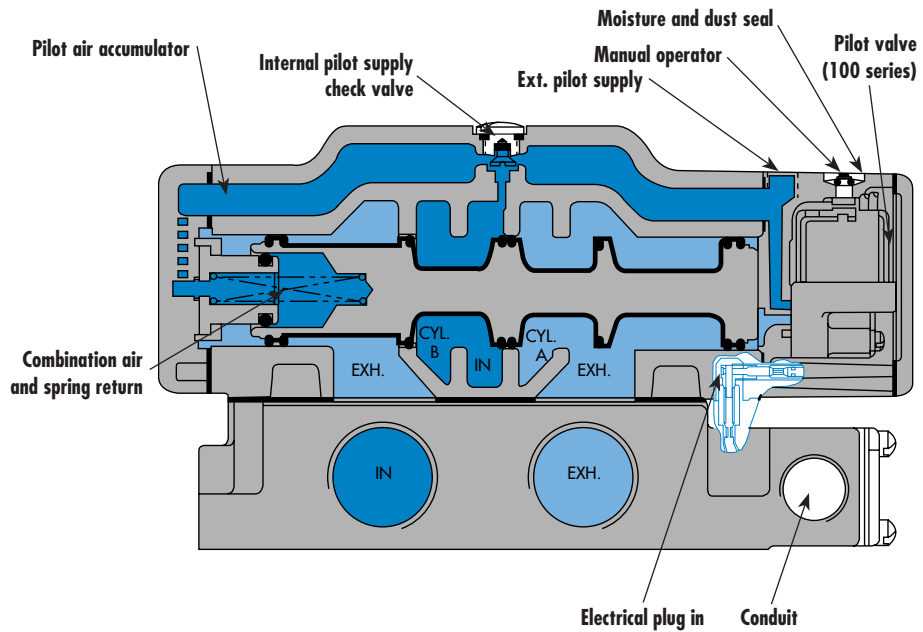

35

100

200

55

56

57

58

59

45

700

900

82

6300

6500

6600

1300

800

ISO 1

ISO 2

ISO 3

MAC 125A

MAC 250A

MAC 500A

SERIES FEATURES

- The patented MACSOLENOID® with its non-burn out feature on AC service.
- A large checked accumulator for consistent shifting on single and double solenoid models.
- A plug-in design that provides for internal or external pilot with or without lights and all electrical in the base.
- Non-lubricated or lubricated service.
- Optional indicator lights, and various types of manual operators.

SOLENOID PILOT

The solenoid pilot utilized on the 1300 Series is the extremely fast and reliable, spring biased MAC 100 Series three-way manifold valve which features a high flow balanced poppet. The patented spring biased floating pole piece MACSOLENOID® of the 100 Series practically eliminates the two most common causes of solenoid valve failures: coil burnout on AC service and failure to shift. The versatility of the 100 Series permits either internal or external pilot supply. The solenoid housing incorporates a 1/8" NPTF pilot exhaust connection which can be either muffled or piped away and the external pilot supply connection.

MAIN VALVE

The main valve contains a MAC all bonded, lightweight one-piece aluminium spool. All spool seals are permanently bonded, precision ground and chemically surface hardened to provide long, stick-free operation. These valves with their pressure balanced design are not affected by restrictions or back pressure in the exhaust and can be plugged for use as three-way valves. The one-piece silicon aluminium body used with any of these valves incorporates an integral accumulator.

ACCUMULATOR

A large accumulator housed in the main valve body supplies both pilots on double solenoid valves as well as the air assisted spring return on single solenoid pilot or single

remote air pilot operated valves. Internally piloted, the accumulator is protected from inlet pressure fluctuations in the main valve by a check valve. The check valve is designed to bleed off the accumulator when the main supply pressure is removed. For external pilot supply operations, the check valve is reversed, blocking the internal pilot supply to the accumulator. The accumulator is then supplied through the external supply connection.

DIFFERENTIAL RETURN

Single solenoid pilot or single air pilot operated models contain a combination spring and air assisted differential return. Supplied from the accumulator it balances the shifting forces for consistent operation and positive spool return.

BASES

The 4-port aluminium base design simplifies piping and enables the use of a single muffler or piped exhaust. They are provided with an integral electrical wiring space, sealed with a convenient access cover. The access cover also houses the optional indicator lights, available in voltages of 120/60, 110/50 or 240/60, 220/50 or 24 VDC in either single or double lights.

3-POSITION VALVES

The 1300 Series solenoid pilot 3-position valves, are centered by MAC's exclusive combination spring and pressure assisted spool design. The combination spring and air assist assures fast, positive return of the main spool when the pilots are de-energized. Available in external or internal pilot supply models, with either a closed center spool (all ports blocked) or open center spool (inlet blocked, cylinder ports open to exhaust).

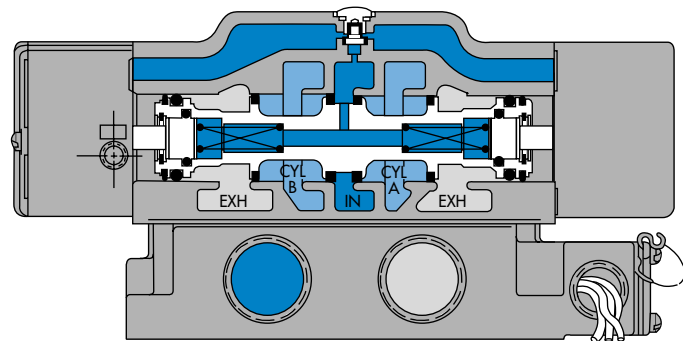

3-POSITION DOUBLE
SOLENOID CLOSED CENTER

Function	Port size	Flow [Max]	Individual mounting	Series
4/2 - 4/3	3/4" - 1" - 1 1/4" - 1 1/2"	15.9 C_v	sub-base "plug-in"	

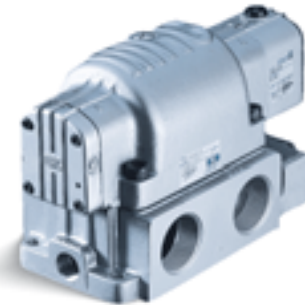

OPERATIONAL BENEFITS

- Balanced spool, immune to variations of pressure.
- Short stroke with high flow.
- High shifting forces.
- Checked accumulator guarantees maximum pilot pressure.
- Powerful return force thanks to the combination of mechanical and air springs.
- Bonded spool with minimum friction, shifting in a glass-like finished bore.
- Wiping effect eliminates sticking.
- Pilot valve with balanced poppet, high flow, short and consistent response times.

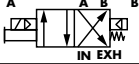
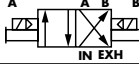

35
100
200
55
56
57
58
59

HOW TO ORDER

Port size	4/2 Single operator	4/2 Double operator	4/3 Closed center	4/3 Open center
				
Valve less base	1301G-XXYD-XX	1303G-XXYD-XX	1307G-XXYD-XX	1308G-XXYD-XX
Sub base 3/4" NPTF	1321G-XXYD-XX	1323G-XXYD-XX	1327G-XXYD-XX	1328G-XXYD-XX
Sub base 1" NPTF	1331G-XXYD-XX	1333G-XXYD-XX	1337G-XXYD-XX	1338G-XXYD-XX
Sub base 1 1/4" NPTF	1351G-XXYD-XX	1353G-XXYD-XX	1357G-XXYD-XX	1358G-XXYD-XX
Sub base 1 1/2" NPTF	1361G-XXYD-XX	1363G-XXYD-XX	1367G-XXYD-XX	1368G-XXYD-XX

45

SOLENOID OPERATOR ▶

XX Y D- X X *

XX Voltage	Y Manual operator	X Pilot air	X Indicator light
11 120/60, 110/50	1 Non-locking	1 Internal	5 With light in base
12 240/60, 220/50	2 Locking	2 External	
22 24/60, 24/50			
59 24 VDC (2.5 W)			
87 24 VDC (17.1 W)			
61 24 VDC (8.5 W)			

700
900
82

* Other options available, see page 357.

Bases	
10952-0005	3/4" BASE ASS'Y - SGL. (NPTF)
10952-0006	3/4" BASE ASS'Y - DBL. (NPTF)
10952-XX05	3/4" BASE ASS'Y - SGL. - W/LIGHT (NPTF)
10952-XX06	3/4" BASE ASS'Y - DBL. - W/LIGHT (NPTF)
10953-0005	1" BASE ASS'Y - SGL. (NPTF)
10953-0006	1" BASE ASS'Y - DBL. (NPTF)
10953-XX05	1" BASE ASS'Y - SGL. - W/LIGHT (NPTF)
10953-XX06	1" BASE ASS'Y - DBL. - W/LIGHT (NPTF)
10954-0005	1 1/4" BASE ASS'Y - SGL. (NPTF)
10954-0006	1 1/4" BASE ASS'Y - DBL. (NPTF)
10954-XX05	1 1/4" BASE ASS'Y - SGL. - W/LIGHT (NPTF)
10954-XX06	1 1/4" BASE ASS'Y - DBL. - W/LIGHT (NPTF)
10955-0005	1 1/2" BASE ASS'Y - SGL. (NPTF)
10955-0006	1 1/2" BASE ASS'Y - DBL. (NPTF)
10955-XX05	1 1/2" BASE ASS'Y - SGL. - W/LIGHT (NPTF)
10955-XX06	1 1/2" BASE ASS'Y - DBL. - W/LIGHT (NPTF)

Light options	
XX =	11 - 110V-120V
	12 - 220V-240V
	61 - 24V-28V

6300
6500
6600
1300

800
ISO 1
ISO 2
ISO 3
MAC 125A
MAC 250A
MAC 500A

BOTTOM PORTS available only on 3/4" valves
For bottom ports only specify **MOD 0002**
For side and bottom ports specify **MOD 0004**
EXAMPLE : 1321G-111D-1 **MOD 0002**

TECHNICAL DATA

Fluid :	Compressed air, vacuum, inert gases		
Pressure range :	Internal pilot : single operator and 3 positions : 25-150 PSI	double operator : 10-150 PSI	
	External pilot : vacuum to 150 PSI		
Pilot pressure :	Single operator and 3 positions : 25-150 PSI Double operator : 10-150 PSI		
Lubrication :	Not required, if used select a medium aniline point lubricant (between 180°F to 210°F)		
Filtration :	40 µ		
Temperature range :	0°F to 120°F (-18°C to 50°C)		
Flow (at 6 bar, ΔP=1bar) :	3/4" : (11.5 C _v), 1" : (13.7 C _v), 1 1/4" : (15.4 C _v), 1 1/2" : (15.9 C _v)		
Coil :	Epoxy encapsulated - class A wires - Continuous duty		
Voltage range :	-15% to +10% of nominal voltage		
Protection :	Consult factory		
Power :	~ Inrush : 14.8 VA Holding : 10.9 VA = 1 to 17.1 W		
Response times :	24 VDC (8.5 W)	Energize : 20 ms	De-energize : 28 ms
	120/60	Energize : 17-23 ms	De-energize : 29-35 ms

- Spare parts :
- Solenoid operator (power ≥ 4 W) : D1-XXBD.
 - Pressure seal between valve and base : 16083.
 - Pilot valve : 150B-XXBD, including mounting screws 32180 and adaptor plate N-03001.
 - Mounting screw valve to base (x4) : 32396.

- Options :
- BSPP threads.
 - Lights in base.

DIMENSIONS

Dimensions shown are metric (mm)

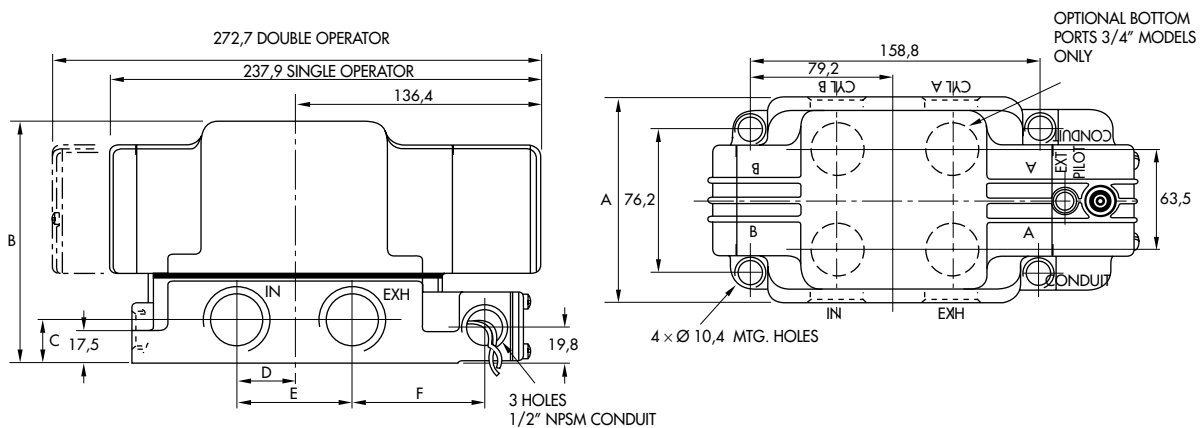

Port size	A	B	C	D	E	F
3/4", 1" NPTF	111.3	132.4	23.8	31.7	63.5	71.4
1 1/4" NPTF	114.3	148.3	30.2	38.1	76.2	65.0
1 1/2" NPTF				35.0	69.9	68.0

Codification table for voltages / Manual operator / Electrical connection / Wire length

VALVE CODE ► **- XX Y ZZ (-VV)**
1 2 3 4

OPTIONS AVAILABLE FOR	OPTIONS AVAILABLE FOR
<ul style="list-style-type: none"> - valves type 100 Series - pilot valves "CNOMO" 	<ul style="list-style-type: none"> - valves type 200 Series
<ul style="list-style-type: none"> - Pilot operated valves with pilots type 100 Series Series : 55 - 56 - 700 - 800 - 900 <li style="padding-left: 20px;">- 6300 - 6500 - 6600 - 1300 <li style="padding-left: 20px;">- ISO 1 - ISO 2 - ISO 3. <li style="padding-left: 20px;">- MAC 125 - MAC 250 - MAC 500 	<ul style="list-style-type: none"> - pilot operated valves with pilots type 200 Series Series : 200 - 57 - 58 - 59.
<ul style="list-style-type: none"> - Pilot operated valves with pilots "CNOMO" Series : ISO1 - ISO2 - ISO3 	

Used on valve series: 100, 55, 56, 700, 800, 900, 6300, 6500, 6600, 1300, MVA1C, MVA2B, MVA3B, MAC125, MAC250, MAC500.

Used on valve series: 200, 57, 58, 59.

1. VOLTAGE (100 Serie type coil)		1. VOLTAGE (200 Serie type coil)	
- XX Y ZZ	VOLTAGE	- XX Y ZZ	VOLTAGE
11	120/60, 110/50	11	120/60, 110/50, 24 VDC (6 W)
12	240/60, 220/50	12	240/60, 220/50
13	100/60, 100/50	13	100/60, 100/50
15	200/60, 200 /50	14	200/60, 200/50
16	10/60	20	6/60
20	6/60	21	12/60
21	12/50, 12/60	22	24/60, 24/50
22	24/60, 24/50	23	32/60, 32/50
23	32/60, 32/50	24	48/60, 42/50
24	48/60, 42/50	25	240/50
26*	380/50, 440/50, 440/60, 480/60	26	480/60, 440/50
29	220/60	27	127/60
34	127/50, 120/50	28	415/50
35	48/50	29	220/60
36	16/60	30	380/50
B1	24/50	31	550/60, 550/50
50	24 VDC (6 W)	32	120/60, 110/50
51	24 VDC (4 W)	33	600/60
54	12 VDC (4 W)	34	127/50
55	12 VDC (6 W)	35	48/50
57	12 VDC (2.5 W)	50	24 VDC (6 W)
59	24 VDC (2.5 W)	51	24 VDC (4.5 W)
60	12 VDC (8.5 W)	52	24 VDC (2.5 W)
61	24 VDC (8.5 W)	53	24 VDC (1.0 W)
64	6 VDC (6 W)	55	12 VDC (6 W)
65	32 VDC (7 W)	57	12 VDC (2.5 W)
66	48 VDC (5.8 W)	58	48 VDC (2.5 W)
67	64 VDC (7.5 W)	60	12 VDC (9.5 W)
68	120 VDC (6.4 W)	61	24 VDC (8.5 W)
69*	220 VDC (8.7 W), 250 VDC (11.2 W)	64	6 VDC (8.5 W)
75	90 VDC (8.8 W)	65	32 VDC (10 W)
76*	100 VDC (6.9 W)	66	48 VDC (11.5 W)
84*	125 VDC (10.9 W)	67	64 VDC (10.5 W)
87*	24 VDC (17.1 W)	68	120 VDC (12.3 W)
88*	12 VDC (17.4 W)	69	250 VDC (9.2 W)
89*	36 VDC (18.8 W)	71	8 VDC (8.2 W)
90	28 VDC (8.2 W)	72	24 VDC (12 W)
91*	6 VDC (10.6 W)	73	198 VDC (10 W)
92	190 VDC (6.5 W)	74	72 VDC (11.3 W)
94	3 VDC (7 W)	75	90 VDC (11.3 W)
95	38 VDC (6.4 W)	76	100 VDC (9 W)
A1	24 VDC (1 W)	77	220 VDC (10 W), 230 VDC (11.6 W)
A2	12 VDC (1 W)	78*	24 VDC (24 W)
A3	9 VDC (1 W)	80	55 VDC (10.6 W)
		82	170 VDC (11.1 W)
		83	15 VDC (8.1 W)
		84	125 VDC (10 W)
		86	36 VDC (11 W)
		93*	12 VDC (24 W)

MOD. DD01 : Protection diode (DC) - MAX. 8.5W

MOD. MOV1 : Protection varistor (AC) - MAX. 8.5W

* Voltages are CLSF only

2. MANUAL OPERATOR (Common options for 100 & 200 Series type coils)

- XX Y ZZ	MANUAL OPERATOR
0	No operator
1	Non-locking recessed
2	Locking recessed
3	Non-locking extended
4	Locking extended

5*	No Operator with Light
6*	Non-Locking Recessed with Light
7*	Locking Recessed with Light
8*	Non-Locking Extended with Light
9*	Locking Extended with Light

* Lights used with "AA" electrical connection

3. ELECTRICAL CONNECTION (100 Serie type coil)

- XX Y ZZ	ELECTRICAL CONNECTION
AA	Wiring box with 1/2" NPS conduit
BA	Flying leads
CA	1/2" NPS conduit
CC	1/2" NPT conduit
FA	Military type 2 PIN
GA	Military type 3 PIN
HA	AA with ground wire
JA*	Square connector
JB	Rectangular connector
JC*	Square connector with light
JD	Rectangular connector with light
JE	Square connector on top (ISO2, ISO3)
JF	Rectangular connector on top (ISO1, ISO2, ISO3)
JG	JE with light
JH	JF with light
JJ	Square connector, male only
JM	Rectangular connector, male only
MA	Electrical common conduit (100 Series-Manifold/900 Series)
MB	Electrical common conduit (100 Series-Stacking/700 Series)
NA	CA with ground wire
NC	CC with ground wire
RA	3/8" NPS conduit

* Not to be used with 100, 800 and 900 Series manifold mounting

3. ELECTRICAL CONNECTION (200 Serie type coil)

- XX Y ZZ	ELECTRICAL CONNECTION
AA	Wiring box with 1/2" NPS conduit
BA	Flying leads
CA	1/2" NPS conduit
CC	1/2" NPT conduit
EA	Explosion proof (200 Series)
EA	Explosion proof (57, 58 & 59 Series)
FA	Military type 2 PIN
GA	Military type 3 PIN
HA	AA with ground wire
JA*	Square connector
JC	Square connector with light
JJ	Square connector, male only
NA	CA with ground wire
NC	CC with ground wire

4. COIL WIRE LENGTH (Common options for 100 & 200 Serie type coils)

- XX Y ZZ (-VV)	WIRE LENGTH
AA	18"
AB	24"
AD	36"
AE	48"
AF	72"
AG	6"
AR	12"
AU	120"
BA	60"
BB	144"
Series 6000 : wire length, from the base	
MOD L024	24"
MOD L036	36"
MOD L048	48"
MOD L060	60"
MOD L072	72"
MOD L120	120"